

PA0405P Switching Mode Power Supply

■ Special Features

- Small multi-purpose power supply
- Wide Input Range (AC85V~265V)
- Isolated output
- Short circuit protection
- Over voltage protection
- Thermal shutdown
- Low standby-power



■ Electrical Characteristics

Characteristics		Condition	Min.	Typ.	Max.	Unit
AC Input	Input Voltage Range	$I_o=700\text{mA}$	85	220	265	V
	Current	$V_i=AC220\text{V}, I_o=700\text{mA}$	-	-	0.1	A
Output	Output Voltage(DC)	$V_i=AC220, I_o=0\sim700\text{mA}$	4.75	5.00	5.25	V
	Output Current	$V_i=AC220, V_o=5.0\text{Vdc}$	-	-	700	mA
	Line Regulation	$V_i=AC85\sim265\text{V}, I_o=700\text{mA}$	-	-	0.2	V
	Load Regulation	$V_i=AC220\text{V}, I_o=0\sim700\text{mA}$	-	-	0.2	V
	Ripple Voltage	$V_i=AC220\text{V}, I_o=700\text{mA}$	-	-	0.2	Vp-p
	Efficiency	$V_i=AC220\text{V}, I_o=700\text{mA}$	-	62	-	%
Power Consumption	No Load	$V_i=AC220\text{V}, I_o=0\text{mA}$	-	-	0.05	W
	Full Load	$V_i=AC220\text{V}, I_o=700\text{mA}$	4.5	5.0	5.5	W
Ambient Temperature	Operating Range	$V_i=AC220\text{V}, I_o=700\text{mA}$	-10	-	70	°C
	Storage Range		-20	-	105	°C

Notes

- (1) For cases where the conformance to various safety spec is required, input voltage and frequency range will be 85VAC ~265VAC, 60Hz/50Hz.

■ External EMI Filter

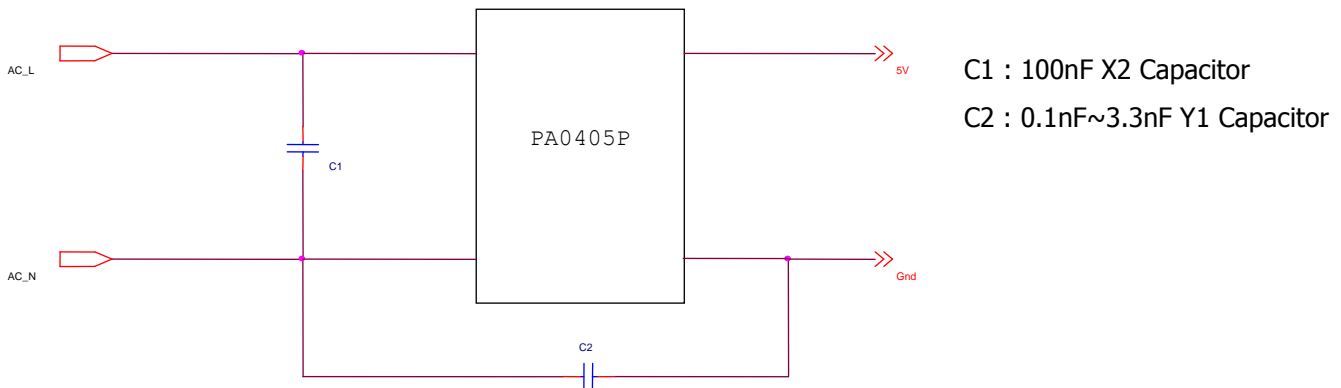

■ Block Diagram

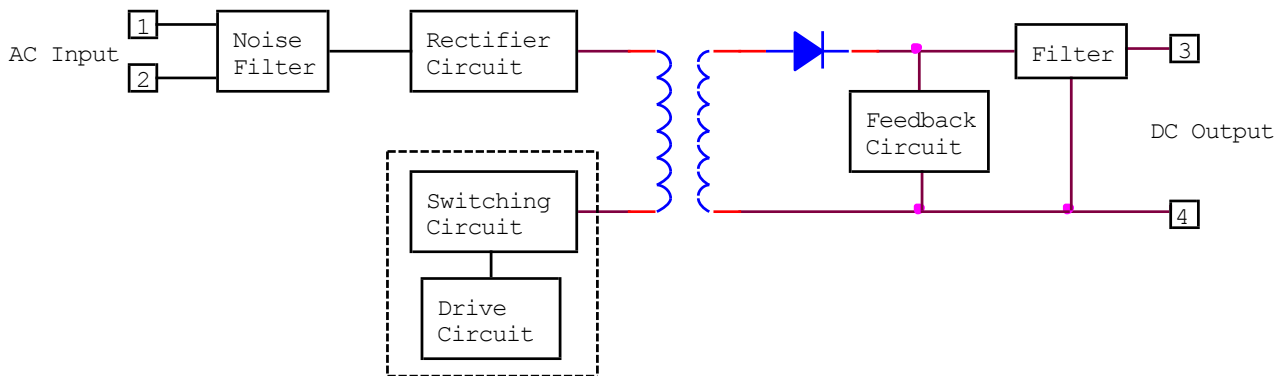

■ Dimension

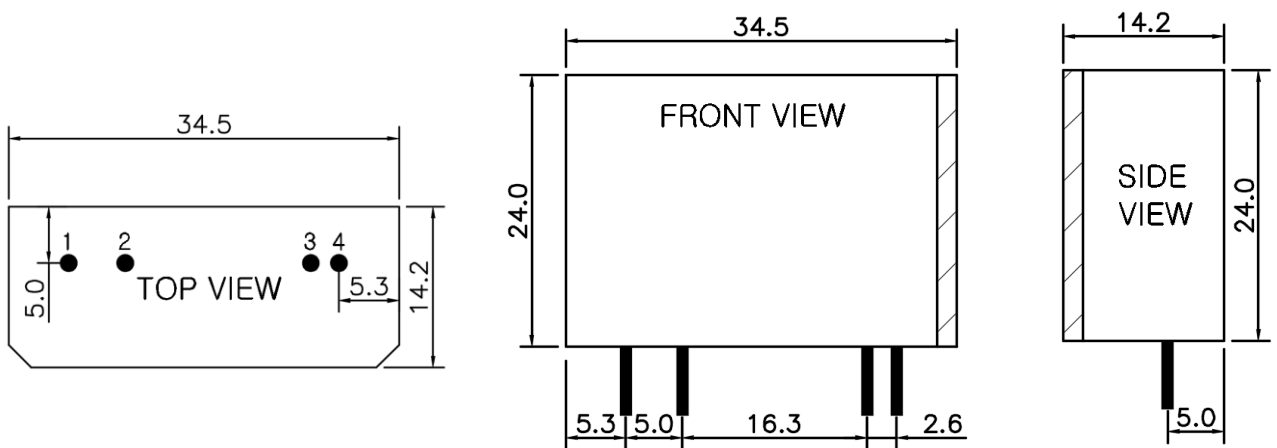

Pin No.	Description
1	AC INPUT (N)
2	AC INPUT (L)
3	DC+ OUTPUT
4	GND

Notes
1.Dimension in mm
2. PIN : Ø 1.0

■ Packing Specification

1. Inner Box

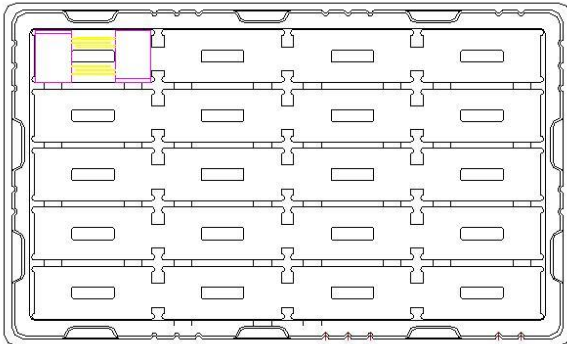

Matter	PET
Quantity	40 pcs (8 X 5)

2. Output Box

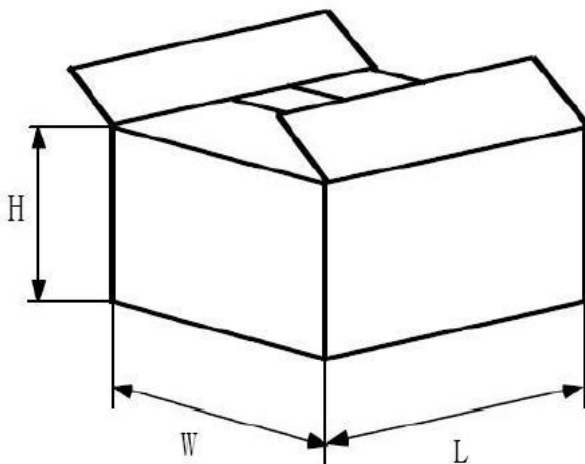

L	460
W	390
H	225
Quantity	1000EA
Marking	1. Maker 2. Part Number 3. Quantity

* Unit : mm

POWERGEN Co., Ltd.

67-13, Shinchon-dong, Changwon si, Gyeongnam, S.Korea, 642-370

TEL : + 82 55 275 7801~4

FAX + : 82 55 275 2522

Homepage : www.pwrg.co.kr

Online shop : www.pwrgmall.co.kr

This semiconductor technical data is believed to be accurate and reliable, however POWERGEN does not assume any responsibility arising out of the application or use of any product or circuit described herein; neither does it convey any license under its patent rights nor the rights of others.

POWERGEN reserves the right at anytime without notice to change said circuitry and specifications.